

ASSEMBLING AND
USING YOUR

Heathkit

OSCILLOSCOPE
MODEL O-7



THE HEATH COMPANY
BENTON HARBOR, MICH.

USEFUL INFORMATION FOR KIT BUILDERS

Resistors are identified by a color code used in several bands around the resistors. There are two general types of resistors. One, the uninsulated type, has the connecting wires bound around the ends. The other, the insulated type, has the wire connected internally and coming out the ends. The resistance code uses three bands or colors, while a fourth, usually silver or gold, indicates the tolerance. The colors are arranged so that the first two indicate the first two figures of the resistance, while the third indicates the number of digits (zeros or multiplier) which follow the first two figures. On uninsulated resistors, the body is the first figure, the end color the second figure, and the dot the number of digits. On insulated resistors, the band nearest the end is the first figure, the next band is the second figure and the third band the number of digits.

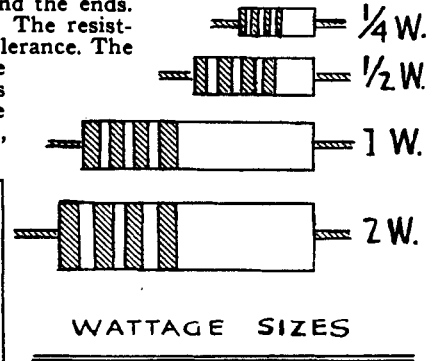

WATTAGE. Resistors are rated as to wattage (power dissipation) according to size. The chart shows approximate sizes which vary with manufacturers. To determine wattage size necessary multiply current through resistor in amperes by voltage drop across resistors in volts. Example—A plate loading resistor for a tube drawing 10 milliamperes (.01 Amperes) has a voltage on one side of 300 volts and on the other side 200 volts, giving a drop of 100 volts. Therefore 100 volts \times .01A. = 1 Watt.
A higher wattage resistor can always be substituted for smaller size.

Uninsulated Insulated	Body Color First Ring	End Color Second Ring	Dot Color Third Ring
Color	First Figure	Second Figure	Number of Digits
Black	0	0	None
Brown	1	1	0
Red	2	2	00
Orange	3	3	000
Yellow	4	4	0,000
Green	5	5	00,000
Blue	6	6	000,000
Violet	7	7	0,000,000
Grey	8	8	00,000,000
White	9	9	000,000,000

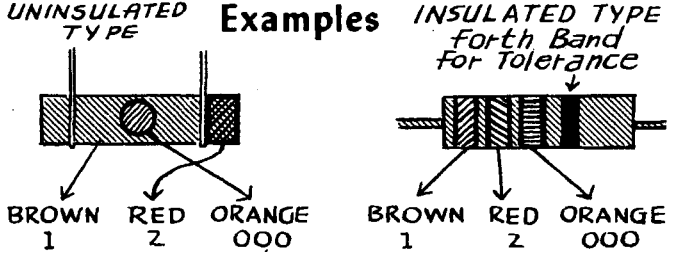

Some Popular Sizes of Resistors

RESISTANCE IN OHMS	BODY OR FIRST BAND	END OR SECOND BAND	DOT OR THIRD BAND
50	Green	Black	Black
250	Red	Green	Brown
1500	Brown	Green	Green
30,000	Orange	Black	Black
220,000	Red	Red	Red
1 Megohm	Brown	Black	Black

The fourth ring or other end may be silver (10% tolerance) or gold (5% tolerance) or it may be omitted entirely which indicates 20% tolerance.

Condenser Code

Condensers use the same code as resistors and are read in micromicrofarads.

If there is one row of dots, they are read in direction of arrow or if manufacturer's name appears in the same direction as name. If two rows of dots appear, it can either be of two different codes: The RMA or the AWS (American War Standard). In the RMA, the top row of dots are the first three figures (carried to three figures), the bottom row are left to right the voltage rating, tolerance, and decimal multiplier.

In the AWS code, the top row of dots are the first three figures while the bottom row are, left to right, characteristic, tolerance, and decimal multiplier.

Examples

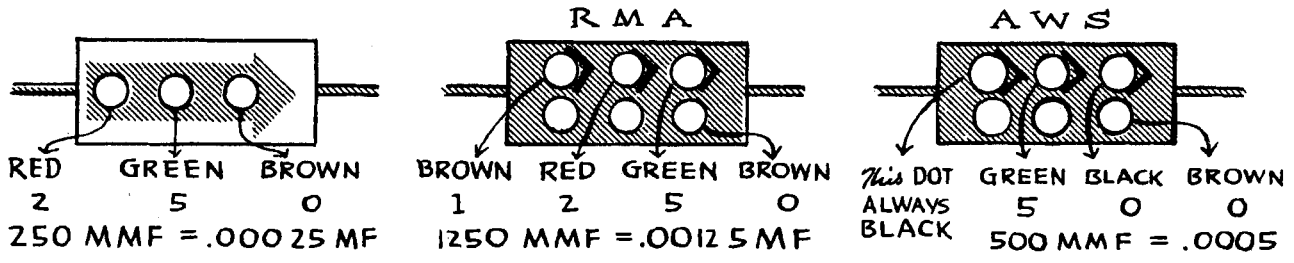

Some Commonly Used Sizes of Condensers

MMF.	MF.	FIRST DOT	SECOND DOT	THIRD DOT
10	.00001	Brown	Black	Black
50	.00005	Green	Black	Black
100	.0001	Brown	Black	Brown
250	.00025	Red	Green	Brown
500	.0005	Green	Black	Brown
1000	.001	Brown	Black	Red
3000	.003	Orange	Black	Red
10,000	.01	Brown	Black	Orange

The tolerance rating corresponds to the color code, i.e., red — 2%, green — 5%, etc.

The voltage rating corresponds to the code multiplied by 100. Example: Orange dot — 300 volt rating; Blue — 600 volt rating.

ASSEMBLY AND OPERATION OF THE HEATHKIT MODEL O-7 OSCILLOSCOPE

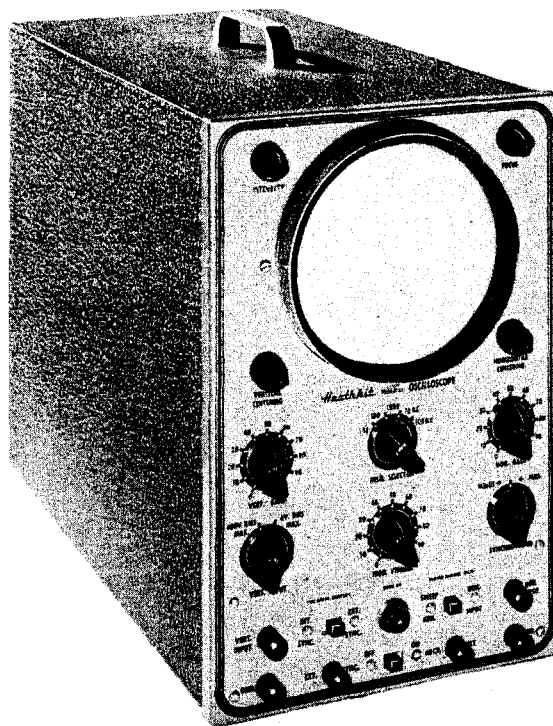

SPECIFICATIONS

Vertical:	Frequency response	+2 db at 10 cy.
	(1 inch deflection at 1 kc reference)	-2 db at 200 kc
		-6 db at 500 kc
		-12 db at 1 mc
		-24 db at 2 mc
	Sensitivity (1 inch deflection at 1 kc)03 volts per inch
	Input impedance	30 MMF shunting 2 Megohm
Horizontal:	Frequency response	+2 db at 10 cy.
	(1 inch deflection at 1 kc reference)	-3 db at 500 kc
		-6 db at 1 mc
		-12 db at 2 mc
		Sensitivity (1 inch deflection at 1 kc)
	Input impedance	25 MMF shunting 1 Megohm
Sweep Generator:	Multivibrator with frequency range of 15 - 100,000 cycles	
Tube Complement:	1 - 5BP1 or 5BP4 or 5GP1 Cathode-ray tube 2 - 6J5 tubes for horizontal and vertical input 1 - 6C4 tube for vertical phase splitter 4 - 12AT7 tubes for hor. and vert. deflection, cascade amplifier, and multivibrator 2 - 5Y3 tubes for high and low voltage rectifiers	
Power Requirements:	105 - 125 volts 50-60 cycle AC 70 watts	
Dimensions:	8½" wide x 13" high x 17½" deep	

ASSEMBLY AND OPERATION OF THE HEATHKIT MODEL O-7 OSCILLOSCOPE

The Heathkit Oscilloscope will offer excellent operating characteristics if properly constructed. To insure many years of troublefree service, the assembly and wiring should be undertaken without hurrying. Take your time to do a good job.

This manual is intended to facilitate proper construction. THEREFORE READ THE MANUAL COMPLETELY THROUGH BEFORE PROCEEDING WITH THE CONSTRUCTION. In this manner you will become familiar with the contents of the manual. Then during construction you can readily refer back to specific paragraphs and pictorials.

UNPACK THE KIT CAREFULLY AND CHECK EACH PART AGAINST THE PARTS LIST. In so doing you will become acquainted with the parts. If a shortage is found, please notify us promptly, and attach the inspection slip to your claim. Screws, nuts and washers are counted mechanically, and if a few are missing, please secure them locally. Use the charts on the inside covers of this manual to identify the parts.

Read the note on soldering on the inside of the back cover. Make a good mechanical connection with clean metal to clean metal. Use only the best quality Rosin Core Radio type solder. Paste fluxes or acids are difficult to remove, and even minute quantities left behind will combine with moisture from the air to form a corrosive product. This corrosive product is generally a good conductor and may cause short circuits between switch contacts or tube socket lugs. After weeks or months the corrosion may result in untimely failure of the instrument.

NOTE: ALL GUARANTEES ARE VOIDED AND WE WILL NOT REPAIR OR SERVICE INSTRUMENTS IN WHICH ACID CORE SOLDER OR PASTE FLUXES ARE USED.

(When in doubt about solder, it is recommended that a new roll plainly marked "Rosin Core Radio Solder" be purchased.)

Resistors and controls generally have a tolerance rating of plus or minus 20%, unless otherwise stated. Therefore a 10,000 ohm resistor may test anywhere from 8,000 to 12,000 ohms. The tolerance on condensers is generally even greater. Limits of minus 50% and plus 100% are common for paper tubular types. This Heathkit is designed to accommodate such variations.

Small changes in parts may be made by the Heath Company. All parts supplied will work just as well as the part for which it was substituted. By reading the color code on resistors, for instance, it will be readily understood that a value of 3.9 megohms is a substitute for the specified 3.3 megohms, or a resistor coded 8200 ohms is a substitute for the specified 10,000 ohms, provided the specified values are not supplied. Such changes will only be made if the specified parts are unobtainable at the time, and are only made to insure a minimum delay in filling your order.

The tube socket pins are numbered from 1 to 7, 8, 9 or 11, starting at the keyway or blank space, as the case may be, and reading clockwise when viewed from the bottom.

Follow the pictorial diagrams for the best placement of the wiring. Make the ground connections (connections to the chassis or panel) as shown in the pictorials. These grounding points have been chosen to minimize inter-action between various parts of the circuit. The sensitivity of the amplifiers makes "lead dress" or placement of the wires quite important.

STEP BY STEP ASSEMBLY

Use of bare wire where indicated will facilitate wiring, but insulated wire may be used.
 Use spaghetti (insulated sleeving) over bare wires on condensers and resistors where necessary to prevent the leads from accidentally touching other bare wires or metal parts.
 Use lockwashers under all 6-32 and 8-32 nuts and between all controls and panel.
 Check off each step in the space provided (✓) as it is completed.

(S) means solder the connection

(NS) means do not solder yet

CHASSIS

- () Mount octal tube socket "A" (vertical cathode follower) as shown, using 6-32 screws and nuts. ✓
- () Mount octal tube socket "B" (horizontal phase splitter) as shown, in the same manner. ✓
- () Mount octal tube socket "D" (H.V. rectifier) as shown, in the same manner. ✓
- () Mount octal tube socket "E" (L.V. rectifier) as shown, in the same manner but also mount 2-lug terminal strip "K" under one nut. ✓
- () Mount noval tube socket "C" (multivibrator) as shown using 3-48 screws and nuts. ✓
- () Mount power transformer as shown, using 8-32 screws and nuts. ✓
- () Mount H.V. filter condenser "F" as shown, using 6-32 screws and nuts. ✓
- () Mount condenser mounting wafer and 2-lug terminal strip "L" as shown, using 6-32 screws and nuts. ✓
- () Slip the banana jack insert into the banana jack "Q" (intensity modulation jack) and install as shown with the speednut. ✓
- () Install the 3/4 rubber grommet. ✓
- () Install the 3/8 rubber grommet for the line cord. ✓
- () Install the 1 megohm control "H" (spot-shape) with a control nut. ✓

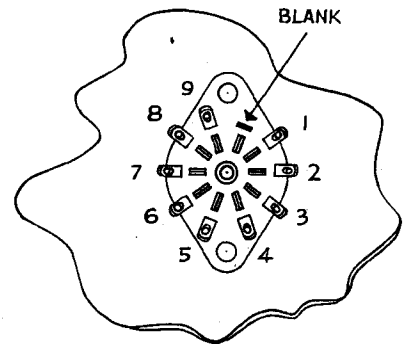
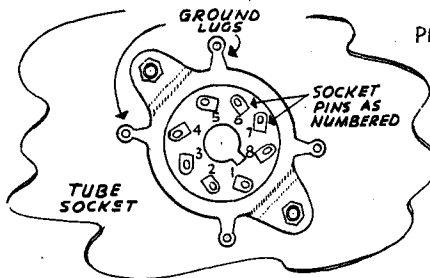
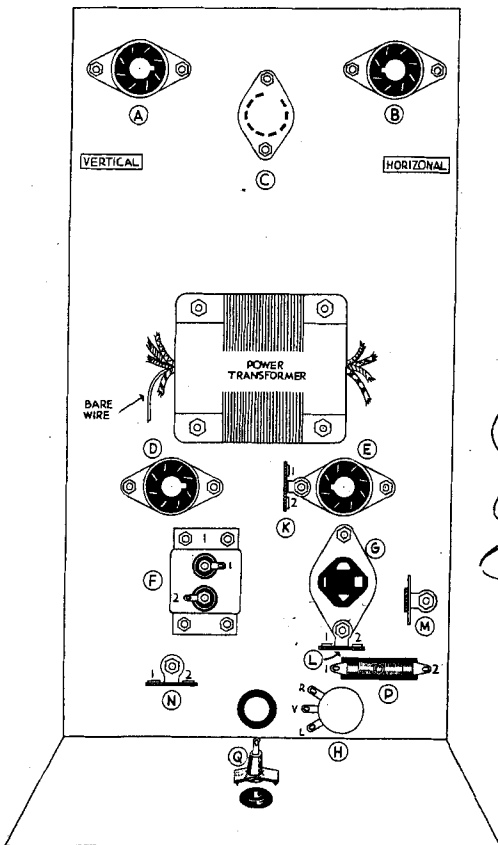

PIN NUMBERING ON NOVAL TUBE SOCKET

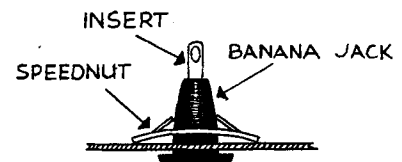

TUBE BRACKET

- () Mount noval tube socket "R" (vertical cascade amplifier), as shown, using 3-48 screws and nuts. ✓
- () Mount noval tube socket "T" (vertical deflection amplifier), as shown, in the same manner. ✓
- () Mount noval tube socket "V" (horizontal deflection amplifier), as shown, in the same manner. ✓
- () Mount miniature tube socket "S" (vertical phase splitter) as shown, using 3-48 screws and nuts. ✓
- () Mount 4-lug terminal strip "W" together with a solder lug as shown, using 6-32 screw and nut. ✓
- () Mount 2-lug terminal strip "X" together with a solder lug as shown, in the same manner. ✓
- () Mount 2-lug terminal strip "Z" together with a solder lug as shown, in the same manner. ✓
- () Mount 2-lug terminal strip "Y" as shown with a 6-32 screw and nut. ✓

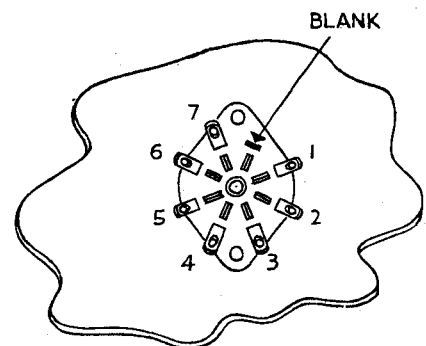
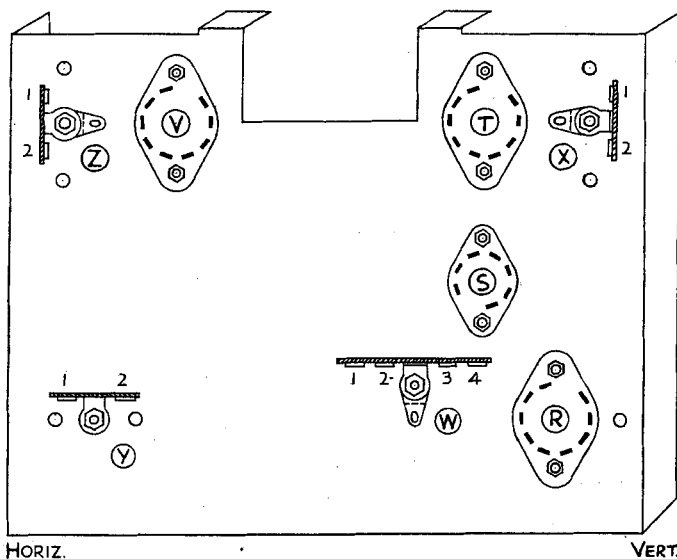

PIN NUMBERING ON MINIATURE TUBE SOCKET

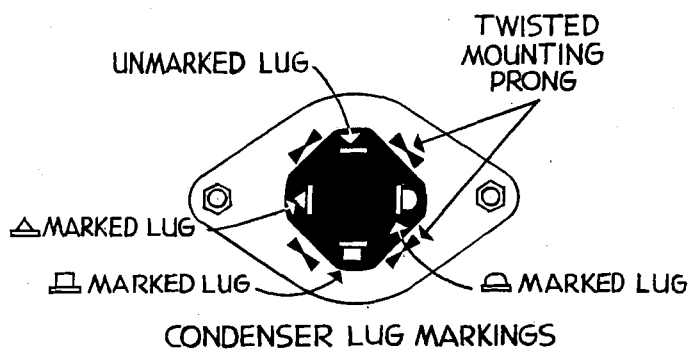

CHASSIS

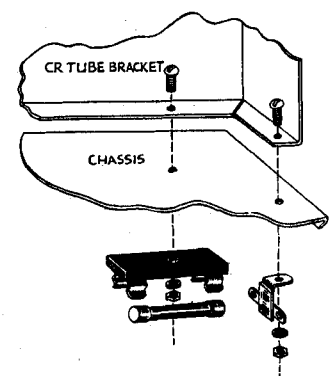

- () Mount the tube bracket on the chassis using 6-32 screws and nuts and at the same time install under the nuts as shown:
 - () A single terminal strip "M" ✓
 - () A fuse block "P" and ✓
 - () A 2-lug terminal strip "N" ✓
 - () Install the fuse. ✓
- () Install L.V. filter condenser "G" on the condenser mounting wafer as shown, by pushing the mounting prongs through the slots in the wafer and then twisting the prongs one-eighth turn with a pair of pliers. ✓

TRANSFORMER WIRING

The leads on components such as transformers, resistors and condensers are frequently longer than necessary. When wiring these parts into the circuit, the leads should be cut to the proper length. Not only will this result in a neater looking instrument, but in many instances proper operation is utterly impossible with long untrimmed lead wires in critical parts of the circuit.

- () Twist the two long brown wires together and place them through the $\frac{3}{4}$ grommet. ✓
- () One brown-yellow wire to pin #2 (S) on socket "E." ✓
- () Other brown-yellow wire to pin #8 (NS) on socket "E." ✓
- () Red wire to pin #4 (S) on socket "E." ✓
- () Red-green wire to pin #6 (S) on socket "E." ✓

- () Red-yellow wire to twisted mounting prong (S) on condenser "G." ✓
- () Twist the two black wires together and place them to terminal strip "L." ✓
- () One black wire to lug L-1 (NS). ✓
- () Other black wire to lug L-2 (NS). ✓
- () Twist the two green wires together and place them to terminal strip "K." ✓

- () One green wire to lug K-1 (NS). ✓
- () Other green wire to lug K-2 (NS). ✓
- () Bare wire to ground lug (S) on socket "D." ✓
- () Yellow wire to pin #8 (S) on socket "D." ✓
- () Yellow-green wire to pin #2 (S) on socket "D." ✓

FILAMENT WIRING

For best results the two filament wires between sockets should be twisted together wherever possible, but just keeping the wires close together and against the chassis will generally produce the same results.

- () A wire to lug K-1 (NS), and to pin #2 (NS) on socket "B." ✓
- () A wire to lug K-2 (NS), and to pin #7 (NS) on socket "B." ✓
- () A wire to pin #2 (NS) on socket "B," and on socket "C" through pin #4 (S) to pin #5 (NS). ✓
- () A wire to pin #7 (NS) on socket "B," and to pin #9 (NS) on socket "C." ✓
- () A wire to pin #5 (S) on socket "C," and to pin #7 (S) on socket "A." ✓

- () A wire to pin #9 (S) on socket "C," and to pin #2 (S) on socket "A." ✓
- () A wire to lug K-1 (S), and through $\frac{3}{4}$ grommet to pin #9 (NS) on socket "R." ✓
- () A wire to lug K-2 (S), and through $\frac{3}{4}$ grommet through pin #5 (NS) to pin #4 (S) on socket "R." ✓
- () A wire to pin #5 (S) on socket "R," and to pin #4 (NS) on socket "S." ✓
- () A wire to pin #9 (S) on socket "R," and to pin #3 (NS) on socket "S." ✓

- () A wire to pin #3 (S) on socket "S," and to pin #9 (NS) on socket "T." ✓
- () A wire to pin #4 (S) on socket "S," and through pin #4 (S) to pin #5 (NS) on socket "T." ✓
- () A wire to pin #9 (S) on socket "T," and to pin #9 (S) on socket "V." ✓
- () A wire to pin #5 (S) on socket "T," and through pin #4 (S) to pin #5 (S) on socket "V." ✓

SOCKET "V"

- () A 470 resistor between pin #8 (S), and solder lug (NS). ✓
- () A 1 meg resistor between pin #7 (NS), and solder lug (NS). ✓
- () A 470 resistor between pin #3 (S), and solder lug (NS). ✓
- () A 1 meg resistor between pin #2 (NS), and solder lug (S). ✓
- () A 22K-1W resistor between pin #1 (NS), and lug Z-1 (NS). ✓

- () A 22K-1W resistor between pin #6 (NS), and lug Z-2 (NS). ✓
- () A .5 condenser, as shown, between lug Z-1 (NS), and lug Z-2 (NS). ✓
- () A .05 condenser between pin #7 (S), and lug Y-1 (NS). ✓
- () A .05 condenser between pin #2 (S), and lug Y-2 (NS). ✓

SOCKET "T"

- () A 470 resistor between pin #3 (S), and solder lug (NS). ✓
- () A 1 meg resistor between pin #2 (NS), and solder lug (NS). ✓
- () A 470 resistor between pin #8 (S), and solder lug (NS). ✓
- () A 1 meg resistor between pin #7 (NS), and solder lug (S). ✓
- () A 22K-1W resistor between pin #1 (NS), and lug X-1 (NS). ✓

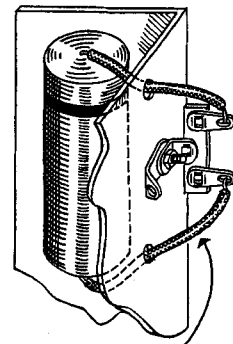

USE SPAGHETTI OVER CONDENSER LEADS

- () A 22K-1W resistor between pin #6 (NS), and lug X-2 (NS). ✓
- () A .5 condenser, as shown, between lug X-1 (NS), and lug X-2 (NS). ✓
- () A .05 condenser between pin #2 (S), and pin #7 (NS) on socket "S." ✓
- () A .05 condenser between pin #7 (S), and pin #1 (NS) on socket "S." ✓

SOCKET "S"

- () A 470K resistor between pin #1 (NS), and lug W-1 (NS). ✓
- () A 10K resistor between pin #1 (S), and lug W-2 (NS). ✓
- () A 10K resistor between pin #7 (NS), and solder lug (NS). ✓
- () A 470K resistor between pin #7 (S), and lug W-4 (NS). ✓
- () A 22K resistor between pin #6 (NS), and lug W-3 (NS). ✓
- () A wire between pin #6 (S), and pin #6 (S) on socket "R." ✓

SOCKET "R"

- () A 470 resistor between pin #8 (S), and solder lug (NS). ✓
- () A 1 meg resistor between pin #7 (NS), and solder lug (NS). ✓
- () A 470 resistor between pin #3 (S), and solder lug (S). ✓
- () A .1 condenser between pin #7 (S) and pin #1 (NS). ✓
- () A 22K resistor between pin #1 (S), and lug W-3 (NS). ✓
- () A 47K resistor between lug W-3 (S), and lug W-2 (NS). ✓

CONDENSER "G"

- () A wire to ∩ marked lug (NS), and to pin #8 (S) on socket "E." ✓
- () A 1000-1W resistor between ∩ marked lug (S), and □ marked lug (NS). ✓
- () A 47K resistor between □ marked lug (NS), and △ marked lug (NS). ✓
- () A 1 meg-2W resistor between twisted mounting prong (NS), and lug "M" (NS). ✓
- () A 15K-2W resistor between □ marked lug (NS), and unmarked lug (NS). ✓
- () A wire to twisted mounting prong (S), and to lug R (NS) on control "H." ✓
- () A wire to □ marked lug (NS), and to lug L (S) on control "H." ✓
- () A wire to unmarked lug (S), and through grommet to lug W-2 (S).
- () A wire to △ marked lug (S), and along chassis edge to pin #4 (NS) on socket "B." ✓
- () A wire to □ marked lug (S), and along chassis edge to pin #6 (NS) on socket "B." ✓

SOCKET "A"

- () A 3.3 meg resistor between pin #5 (NS), and ground lug (S). ✓
- () A 3300 resistor between pin #8 (NS), and ground lug (NS). ✓
- () An 8 MFD condenser with the end marked "positive" or + to pin #3 (NS), and the other end through ground lug (S) to pin #1 (S).

- () A 47K resistor between pin #3 (S), and pin #4 (NS). ✓
- () A wire to pin #4 (S), and to pin #6 (NS) on socket "B." ✓

SOCKET "B"

- () A 470 ohm resistor with one end to ground lug (NS) and other end through pin #3 (S) on Socket "C" to pin #8 (S) on Socket "C." ✓
- () An 8 MFD condenser with the end marked "positive" or + to pin #4 (NS), and the other end ✓ to ground lug (S).
- () A 1 meg resistor between pin #5 (NS), and ground lug (S). ✓
- () A bare wire to pin #1 (S), and to adjacent ground lug (S). ✓

CONDENSER "F"

- () A wire to lug F-1 (S), and to ground lug (S) on socket "D." ✓
- () A wire to lug F-2 (NS), and through pin #4 (S) on socket "D" to pin #6 (S) on socket "D." ✓
- () A wire to lug F-2 (S), and to lug N-2 (NS). ✓

PANEL MOUNTING I

- () Mount the 50K intensity control "AA" with a control lockwasher between control and panel ✓ and a nickel washer between control nut and panel.
- () Mount the 500K focus control "BB" in the same manner. ✓
- () Mount the 50K vertical centering control "CC" in the same manner. ✓
- () Mount the 50K horizontal centering control "DD" in the same manner. ✓
- () Mount the 5K vertical gain control "EE" in the same manner. ✓
- () Mount the frequency selector switch "FF" in the same manner. ✓
- () Mount the dual 5K horizontal gain control "GG" in the same manner. ✓
- () Mount the vertical input switch "HH" in the same manner but include the trimmer mounting ✓ bracket between switch and panel.
- () Mount the 1 meg-8 meg dual vernier control "KK" in the same manner. ✓
- () Mount the 200K CT synchronizing control "LL" in the same manner. ✓
- () Mount the sync. selector slide switch "MM" with 6-32 screws and nuts. ✓
- () Mount the horizontal input selector slide switch "NN" in the same manner. ✓
- () Mount the on-off slide switch "QQ" in the same manner. ✓
- () Mount the pilot light assembly "PP" as shown, and install the pilot lamp. ✓

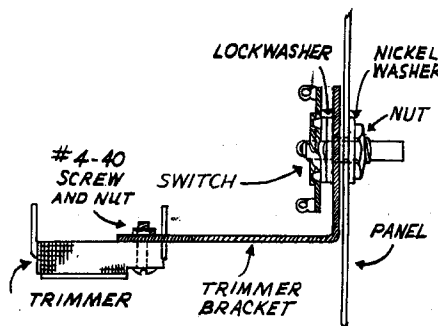
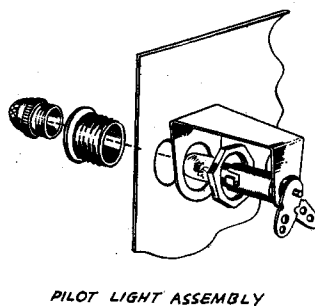
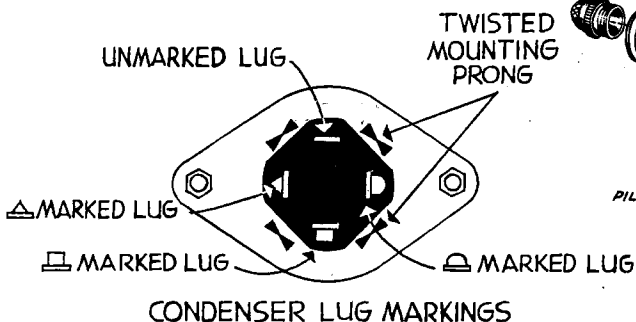
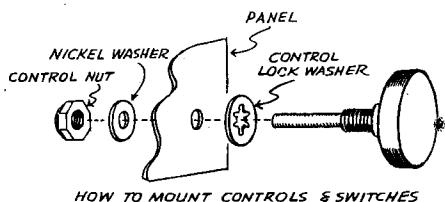

- () Install the vertical input binding post "RR" as shown. ✓
- () Install the external sync. binding post "SS" as shown. ✓
- () Install the 60 cy. test binding post "VV" as shown. ✓
- () Install the horizontal input binding post "XX" as shown. ✓
- () Install the vertical GND. binding post below "RR" with a 6-32 nut. ✓
- () Install the horizontal GND. binding post below "XX" with a 6-32 nut. ✓

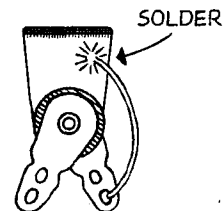
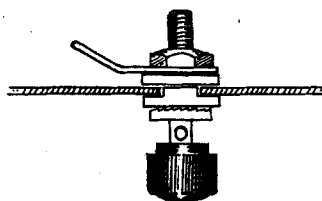
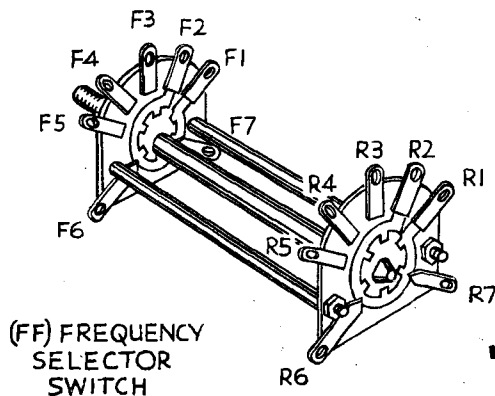

FREQUENCY SELECTOR SWITCH "FF"

- () A .25 condenser between lug F1 (S), and lug R1 (S). ✓
- () A .02 condenser between lug F2 (S), and lug R2 (S). ✓
- () A 2000 condenser between lug F3 (S), and lug R3 (S). ✓
- () A 270 condenser between lug F4 (S), and lug R4 (S). ✓
- () A 27 condenser between lug F5 (S), and lug R5 (S). ✓

PANEL MOUNTING II

- () Install the CR tube panel ring with #6 sheet metal screws. ✓
- () Mount the 4-30 trimmer "TT" on the trimmer bracket with 4-40 screws and nuts. ✓

PANEL WIRING

- () A 220K resistor between lug L (S) on "BB," and after splicing on a length of wire to lug L (S) on "AA."
- () A wire to lug V (S) on "CC," and to lug V (NS) on "DD." ✓
- () A wire to lug F7 (S) on "FF," and to lug FR (NS) on "KK." ✓
- () A wire to lug FR (S) on "KK," and to lug FL (NS) on "GG." ✓
- () A wire to lug FL (S) on "GG," and to lug CT (NS) on "LL." ✓
- () A 47K resistor between lug FV (S) on "KK," and lug F6 (NS) on "FF." ✓
- () A 680K resistor between lug RR (S) on "KK," and lug R7 (NS) on "FF." ✓
- (+) A 100K resistor between lug RV (NS) on "KK," and lug R6 (NS) on "FF." ✓
- () A .02 condenser between lug L (S) on "LL," and lug 2 (S) on "MM." ✓
- () A .02 condenser between lug R (S) on "LL," and lug 5 (S) on "MM." ✓
- () A wire to lug RV (S) on "KK," and to lug 6 (S) on "NN." ✓
- () A wire to lug R7 (S) on "FF," and with some slack to clear chassis edge to lug 3 (NS) on "NN."
- () A bare wire to lug "XX" (S), and to lug 1 (S) on "NN." ✓
- () A 10K resistor between lug "VV" (S), and lug 1 (NS) on "PP." ✓
- () A bare wire to lug 2 (NS) on "PP," and to bracket (S) as shown. ✓
- () A bare wire to lug "SS" (S), and through lug 4 (S) on "MM" to lug 1 (S) on "MM." ✓

VERTICAL INPUT SECTION WIRING

- () A 47K resistor between lug R (NS) on "HH," and lug L (NS) on "EE."
- () A 1000 condenser between lug R (S) on "HH," and lug L (NS) on "EE."
- () A .25 condenser between lug "RR" (S), and lug L₁ (NS) on "HH."
- () A bare wire to lug 1 (S) on "TT," and to lug L (NS) on "HH."
- () A 3.3 meg resistor between lug L (S) on "HH," and lug 2 (NS) on "TT."
- () A bare wire to lug V (S) on "HH," and to lug 2 (NS) on "TT."

PANEL TO CHASSIS MOUNTING

- () Fasten one panel bracket to the panel with 6-32 screws and nuts.
- () Fasten other panel bracket to the panel in the same manner.
- () Fasten the angle bracket to the shield plate as shown.
- () Fasten the shield plate to the chassis with a 6-32 screw.
- () Fasten the panel brackets to the chassis with 6-32 screws and nuts.

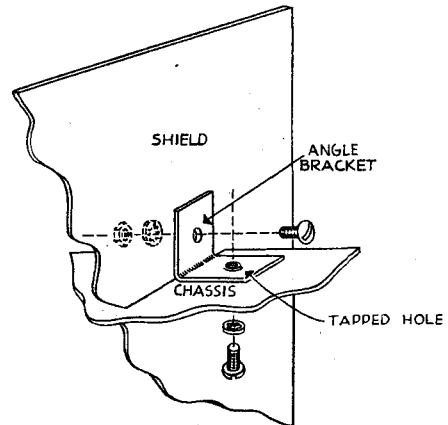
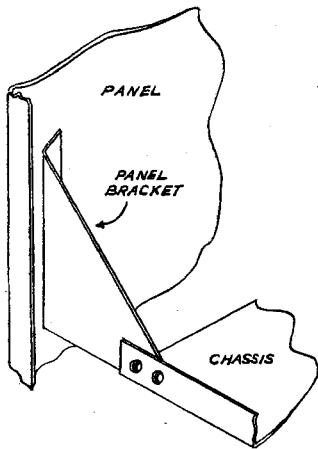

CR TUBE MOUNTING

- () Install the CR tube and fasten the base with the mounting clamps as shown using 6-32 screws and nuts.
- () Install the CR tube socket.

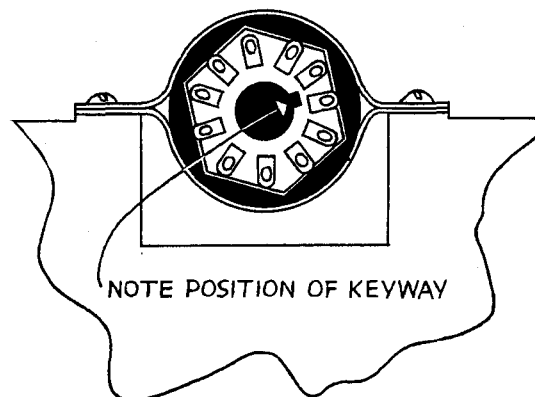
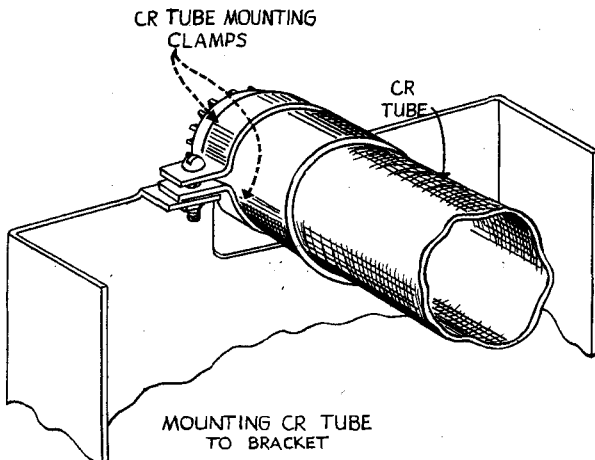

PANEL TO CHASSIS WIRING

- () A 10 MFD condenser with the end marked "positive" or + to pin #8 (S) on socket "A" and the other end to lug R (S) on "EE."
- () A wire to lug L (S) on "EE," and to ground lug (S) on socket "A." ✓
- () A bare wire to lug 2 (S) on "TT," and to pin #5 (S) on socket "A." ✓
- () A wire to lug F6 (S) on "FF," and to pin #7 (S) on socket "C." ✓
- () A wire to lug R6 (S) on "FF," and to pin #1 (S) on socket "C." ✓

- () A wire to lug 3 (S) on "NN," and to pin #6 (S) on socket "C." ✓
- () A wire to lug V (S) on "LL," and to pin #2 (S) on socket "C." ✓
- () A wire to pin #2 (S) on socket "B," and to lug 1 (S) on "PP." ✓
- () A wire to pin #7 (S) on socket "B," and to lug 2 (S) on "PP." ✓
- () A wire to pin #8 (S) on socket "B," and to lug FR (S) on "GG." ✓

- () A wire to pin #4 (S) on socket "B," and to lug RL (S) on "GG." ✓
- () A wire to pin #3 (S) on socket "B," and to lug RR (S) on "GG." ✓
- () A wire to lug CT (S) on "LL," and to ground lug (S) on socket "B." ✓
- () A wire to lug 5 (S) on "NN," and to pin #6 (NS) on socket "B." ✓
- () A wire to lug V (S) on "DD," and along panel bracket to pin #6 (S) on socket "B." ✓
- () A .25 condenser between lug 2 (S) on "NN," and pin #5 (S) on socket "B." ✓

LONG WIRES FROM THE PANEL

- () A 29" long wire (1) to lug L (S) on "CC," and along panel bracket and chassis edge through 3/4 grommet and between "S" and "R" to X-1 (S).
- () A 30" long wire (2) to lug R (S) on "CC," and as above X-2 (S). ✓
- () A 25" long wire (3) to lug 3 (S) on "MM," and through 3/4 grommet to W-4 (S). ✓
- () A 24" long wire (4) to lug 6 (S) on "MM," and as above to W-1 (S). ✓
- () A 45" long wire (5) to lug V (S) on "AA," and around "BB" along edge of panel, panel bracket and chassis, through 3/4 grommet to pin #11 (NS) on CR tube socket. ✓

- () A 37" long wire (6) to lug R (S) on "AA," and as above to lug N-2 (NS). ✓
- () A 36" long wire (7) to lug V (S) on "BB," and as above to pin #4 (S) on CR tube socket. ✓
- () A 25" long wire (8) to lug R (S) on "BB," and as above to lug "M" (S). ✓
- () A 31" long wire (9) to lug R (S) on "DD," and as above to lug Z-1 (S). ✓
- () A 31" long wire (10) to lug L (S) on "DD," and as above to lug Z-2 (S). ✓

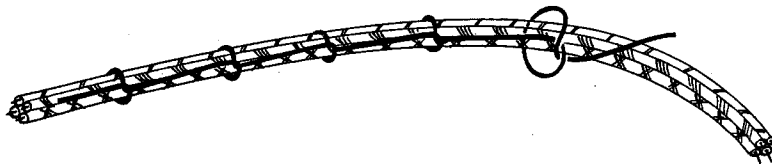

NOTE: The long wires that do not carry signal, such as all those above, can be grouped if run alongside each other and lacing them together with lacing cord, dial cord or string as shown, will present a professional appearance. Narrow strips of tape every few inches may bring similar results.

WIRING THE CR TUBE SOCKET

- () One of the brown twisted transformer leads to pin #11 (S). ✓
- () Other brown transformer lead to pin #1 (S). ✓

- () A wire to pin #3 (S), and to pin #1 (S) on socket "T."
- () A wire to pin #6 (S), and to pin #1 (S) on socket "V."
- () A wire to pin #7 (S), and through $\frac{3}{4}$ grommet to lug V (S) on "H."
- () A wire to pin #8 (S), and to pin #6 (S) on socket "T."
- () A wire to pin #9 (S), and to pin #6 (S) on socket "V."
- () A wire to pin #10 (S), and through $\frac{3}{4}$ grommet to lug N-1 (NS).

FINAL WIRING

- () A 10K resistor between lug N-2 (S), and lug N-1 (NS).
- () A .01-2000V condenser between lug N-1 (S), and banana jack "Q" (NS).
- () A 470K resistor between banana jack "Q" (S), and lug R (S) on "H."
- () A wire to lug L-2 (S), and to lug 2 (S) on "QQ."
- () A wire to lug P-2 (S), and to lug 1 (S) on "QQ."
- () Place the line cord through the line cord grommet and tie a knot for strain relief.
- () One wire of the line cord to lug P-1 (S).
- () Other wire of the line cord to lug L-1 (S).
- () A wire to lug V (S) on "EE," and directly through small hole in tube bracket to pin #2 (S) on socket "R."
- () A wire to lug RV (S) on "GG," and directly through small hole in tube bracket to lug Y-2 (S) but leave a little slack to permit insertion of tube in socket "B."
- () A wire to lug FV (S) on "GG," and directly through small hole in tube bracket to lug Y-1 (S).

COMPLETE THE INSTRUMENT AND PREPARE THE CABINET

- () Install the tubes in their proper sockets.
- () Install the knobs on the controls. The knob on the Frequency Selector switch should point between the panel markings which indicate the approximate limits of the range selected.
- () Install the handle in the top of the cabinet with 10-24 screws.
- () Install the rubber feet in the bottom of the cabinet.

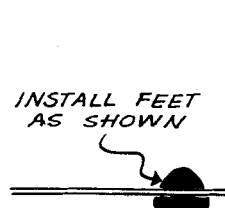
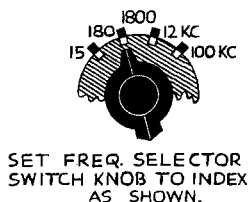

BASIC PRINCIPLES OF OPERATION

The cathode ray tube consists of an electron gun, which shoots a stream of electrons toward the fluorescent screen. The screen lights up where the electrons hit. The amount of electrons that hit the screen, and therefore the brightness of the spot, is controlled by the intensity control. The size of the spot is controlled by the focus control.

After leaving the electron gun, the electron stream passes between two sets of parallel deflecting plates, which are set at right angles. The electron stream can be attracted to or repelled by these deflecting plates, by placing a positive or negative charge on these plates. Such charges or voltages bend the beam and thus move the position of the spot on the screen.

About 50 volts potential difference between a pair of plates is required to deflect the spot one inch. Therefore amplifiers must be used in an oscilloscope, if small voltages are to be observed clearly. Gain controls in the amplifier circuits permit adjustment of the size of the pattern on the screen.

The centering controls vary the normal (no signal) deflecting plate voltages, and thus permit the undeflected spot to be centered on the screen.

The sweep generator produces a sawtooth type of voltage. When applied to the horizontal deflecting circuit, this voltage will cause the spot to move at a steady rate across the screen. At the end of its travel the spot will rapidly return to its starting point, only to begin moving again at a steady rate. This steady movement is called the trace, and the rapid return is known as the retrace.

If, in addition to the sweep signal in the horizontal amplifier, a signal is applied to the vertical amplifier, the spot will not only move left and right, but also up and down. Therefore the spot will trace the shape of the amplitude of the vertical signal with respect to time, which is the customary way to display such signals.

Frequently other horizontal signal sources are used, and these are then connected to the horizontal amplifier in place of the internal sweep generator.

OPERATION OF THE OSCILLOSCOPE

The operation of an oscilloscope and its many controls is quite simple once the basic principles are clear.

The controls can be divided into groups with specific functions.

Two knobs, marked INTENSITY and FOCUS, control the quality of the trace. The intensity knob adjusts the brightness and the focus knob the sharpness of the trace on the oscilloscope screen.

Two knobs, marked VERTICAL CENTERING and HORIZONTAL CENTERING, control the location of the trace on the screen. Turning the vertical knob shifts the trace up or down, and the horizontal knob moves the trace to left or right on the oscilloscope screen.

One knob, marked HOR. GAIN, varies the width of the pattern on the oscilloscope screen.

Two knobs, marked VERT. GAIN and VERT. INPUT, control the height of the pattern on the screen.

Three knobs, marked FREQ. SELECTOR, FREQ. VERNIER, and SYNCHRONIZING, control the operation of the sweep generator. The selector switch and vernier control permit selection of a suitable sweeping rate to provide a clear pattern. The synchronizing knob provides the stabilizing action needed to keep the pattern from drifting left or right.

The slide switch, marked SWEEP GEN.—HOR. INPUT, connects the horizontal amplifier either to the horizontal input binding post on the panel, or to the sweep generator.

The slide switch, marked INT. SYNC.—EXT. SYNC., enables the sweep generator to be locked-in with the signal being fed into the vertical amplifier, or with a signal from an external source.

The slide switch, marked OFF—ON, turns the whole instrument on or off.

Commonly the signal to be observed is applied to the binding posts marked VERT. INPUT and GND. To observe this signal on a basis of time, a "time base" or sweep generator is used as the horizontal signal source. This sweep generator is then adjusted to provide a suitable sweep frequency, as indicated by a single steady trace on the screen. The pattern is then "locked-in" with a slight amount of synchronizing signal as controlled by the synchronizing knob.

The intensity modulation jack at the rear of the chassis provides a way to vary the brightness of the trace with a signal. The use of sine waves will vary the brightness smoothly, while square wave or pulse type signals will enable the trace to be partially blanked out resulting in a dotted line trace. Note that the relative size of the coupling condenser and CR tube grid resistor forms a differentiating circuit for square waves of lower frequencies, and the resulting positive and negative spikes produce momentary brightening and blanking of the trace. The input signal

should be preferably in the order of 15 volts or larger. By using a signal of good frequency accuracy, measurement of time intervals on the trace may be made with equal accuracy.

The input voltage to the horizontal and vertical input binding posts should not exceed the rating of the input blocking condensers, which is 600 volts. This value is the peak value, which may consist of a DC voltage plus the peak of an AC voltage. Application of voltages in excess of 600 volts peak may result in breakdown of the blocking condenser and damage to the instrument.

The maximum R.M.S. signal voltage applied to the vertical input binding post should not exceed the values specified on the panel (6 volts and 400 volts R.M.S.). Larger signals may overload the input cathode follower tube and result in distortion of the trace.

Similarly the maximum R.M.S. signal voltage applied to the horizontal input binding post should not exceed 10 volts R.M.S.

TESTING THE OSCILLOSCOPE

CAUTION

THE VOLTAGES IN THIS INSTRUMENT ARE DANGEROUS. EXTREME CARE SHOULD BE EXERCISED WHENEVER THE INSTRUMENT IS CONNECTED TO THE AC LINE WITHOUT BEING INSTALLED IN ITS CASE.

NOTE particularly that the INTENSITY and FOCUS controls carry some of the highest voltages in the instrument, and as they are located just below the top edge of the panel, the constructor should make sure the instrument is turned off before attempting to pick it up by the top edge of the panel.

Plug the line cord into a 110 volt 50/60 cycle AC outlet only. (Caution: This instrument will not operate and the power transformer may be damaged if plugged into a DC outlet.)

Switch the instrument on and allow a minute for the tubes to heat up. Turn the Intensity control nearly full on (clockwise) and if a trace is seen, adjust the Focus control to produce a clear line or spot. DO NOT PERMIT A HIGH INTENSITY SPOT TO REMAIN STATIONARY ON THE SCREEN FOR ANY LENGTH OF TIME. This may destroy the fluorescent material of the screen and leave a spot where no trace will be obtained.

If no indication is seen, proceed as follows: Connect a wire to the 60 Cycle Test post and to the Vertical Input post. Set the Vertical Input switch to 6 Volt Max. and turn the Vertical Gain control one quarter to one half on. Set the Sweep Generator-Horizontal Input switch to Sweep Generator, and turn the Horizontal Gain control to one half on. Rotate the Centering controls and center the pattern on the screen. This procedure may be necessary as the spot may have been positioned off the screen.

Turn the Vertical gain and input controls counter-clockwise. Set the slide switch to Horizontal input and turn the Horizontal gain control counter-clockwise. Keep the intensity of the resulting spot rather low by adjusting the intensity control. Turn the Spot shape control on the rear of the chassis to produce as round a spot as possible, while keeping the spot size to a minimum with the focus control. The setting of the spot shape control is not very critical, but it may require readjustment when the CR tube is replaced. CAUTION: When adjusting the spot shape control, make sure not to touch the exposed wiring on the CR tube bracket.

Check the sweep generator. Connect the 60 Cycle Test voltage to the Vertical Input binding post as above. Set the Frequency Selector between 15 and 180. Set the Synchronizing control to the mid position. Adjust the Fine Frequency control until a trace of four sine waves is on the screen. The sweep generator is now operating at $60/4 = 15$ cycles per second. This is the approximate minimum sweeping rate.

If a square wave generator is available, adjust the step attenuator as follows: Apply a square wave of preferably 10,000 cycles to the Vertical Input post. Set the Vertical Gain at maximum and turn the Vertical Input switch to the 400 Volt Max. position. Adjust the trimmer under the Vertical Input switch for as flat a top on the square wave as possible. Reduce the frequency of the square wave to 1,000 cycles and make sure that there is no overshoot. Now the frequency response in the 400 Volt Max. position should be equal to the response in the 6 Volt Max. position.

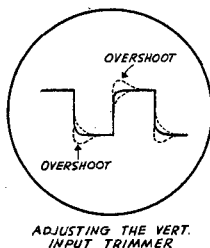

If a square wave generator is not available, this adjustment can not readily be made. In that case, however, the failure to make this adjustment will generally not be evident in any application not involving the use of square waves.

NOTE: At maximum gain settings, the sensitivity of the amplifiers is very high. Therefore, without a signal source connected to the input terminals, stray pickup may produce patterns on the screen. This is equivalent to the noise obtained from high gain audio amplifiers when the pickup or the microphone is disconnected. Such behavior is a normal characteristic of the instrument and does not interfere with proper operation.

The maximum undistorted output voltage of the amplifiers does generally not provide deflection much in excess of five inches. Maximum deflection of four inches, both horizontal and vertical, will provide adequate utilization of the available screen area.

At low sweep rates (30 cycles or less) the screen has insufficient persistence to provide a steady picture. This flicker is inherent with medium persistence screens at low sweep rates.

Test leads are not supplied with this instrument as the wide variety of applications require a large number of different leads, both shielded and unshielded.

After the tests are successfully carried out, the instrument should be installed in the cabinet. Bring the line cord through the hole in the rear of the cabinet. Slide the instrument into the cabinet and fasten with two #6 sheet metal screws through the rear of the cabinet into the rear of the chassis. Trim the grid screen to fit snugly against the felt inside the CR tube panel ring. Recheck the adjustment of the input trimmer, as the presence of the case may change the stray capacity.

IN CASE OF DIFFICULTY

If the testing procedure outlined above does not produce the expected results, locate the trouble as outlined.

1. Check the wiring by following each wire on the pictorial and in the instrument, checking the soldered connections on each end, and then checking off the wire in the pictorial with a colored pencil. This will reveal mistakes and omissions in wiring, which is the most frequent cause of difficulties.
2. Check the voltages at the tube sockets. The readings should come reasonably close to the values tabulated below, if a vacuum tube voltmeter with 11 megohm input resistance is used. Other type meters may give considerably lower readings. If a voltage reading fails to check with the tabulation, check further into the circuit involved (by checking the resistors and condensers for instance), and determine the cause.

SOCKET	A	B	C	D	E	R	S	T	V	CR
PIN NO.	6J5	6J5	12AT7	5Y3	5Y3	12AT7	6C4	12AT7	12AT7	5BP1
1	0	0	80-110	N.C.	N.C.	25-45	140-180	140-180	140-180	1200-1300 NEG
2	*	*	0	700-800 AC	350-390	0	N.C.	0	0	N.C.
3	220-250	240-270	0.5-1.5	N.C.	N.C.	0.5-1.0	*	1.0-2.5	1.0-2.5	140-180
4	TIE POINT	TIE POINT	*	1200-1300 NEG	300-350 AC	*	*	*	*	800-1100 NEG
5	0	0		N.C.	N.C.		140-180			I.C.
6	N.C.	TIE POINT	30-50	1200-1300 NEG	300-350 AC	25-45	25-45	140-180	140-180	140-180
7	*	*	1-15 NEG	N.C.	N.C.	0	30-50	0	0	0-390
8	8-10	10-12	0.5-1.5	700-800 AC	350-390	0.5-1.0		1.0-2.5	1.0-2.5	140-180
9			*			*		*	*	140-180
10										1200-1300 NEG
11										1200-1300 NEG

N.C. means no connection.

I.C. means internal connection used during construction of the tube.

* HEATER VOLTAGE BETWEEN THESE PINS IS 5-7 VOLTS A.C.

VOLTAGES HIGHER THAN 1000 MEASURED WITH A HIGH VOLTAGE PROBE AND VTVM.

3. If the intensity control is open, do not replace it with a new unit. Write to the Heath Company, and we will advise you how to correct this trouble properly.
4. If a part is found to be faulty, please return it promptly for a replacement, and attach a letter to the package describing the nature of the fault.
5. Should the procedure as outlined fail to bring the desired results, write to the Heath Company, describing the difficulties by giving all possible details, such as voltage readings obtained and indications if any. We will attempt to analyze your trouble and advise you accordingly.

IN ALL CORRESPONDENCE REFER TO THIS INSTRUMENT AS THE MODEL 0-7 OSCILLOSCOPE.

If the CR tube has to be replaced because of failure, or because a more brilliant trace is required for laboratory work or for photography of the trace, we recommend the use of a DUMONT type 5BP1-A tube. This tube is far superior to the war surplus 5BP1 types. The trace is much more intense and focussing is improved. While the price is considerably higher, the results justify its use.

CIRCUIT DESCRIPTION

POWER SUPPLY. The operating voltages are supplied through a power transformer. Two rectifiers are used. One rectifier in a full-wave circuit supplies the amplifiers with plate voltages. The output from this rectifier is filtered by a resistance-capacity network. The other rectifier is connected in a half-wave circuit, and provides the large negative voltage for the cathode ray tube. Filtering in this circuit is accomplished by a single high voltage condenser. This simple filter is adequate because the current drain of this circuit is very low.

CR TUBE CIRCUIT. The high voltage condenser is shunted by a voltage divider. The voltages for the CR tube are obtained at various taps along this divider. The grid voltage is obtained from the high voltage condenser through a grid resistor. The cathode voltage is adjustable and is obtained from the intensity control. The focussing anode voltage is also adjustable and is obtained from the focus control. The second anode voltage is obtained from the spot shape control across the amplifier plate supply voltage. The DC as well as the AC voltages for the deflecting plates are obtained directly from the amplifier plates.

HORIZONTAL AMPLIFIER. The horizontal amplifier consists of a triode phase splitter with a dual control (horizontal gain) providing the plate and cathode load resistors. The resulting low impedance lines feed the push-pull amplifier on the tube bracket. The amplifier plates are directly connected to the CR deflecting plates. The plate load consists of two resistors and the centering control. The plate voltages, and thus the spot position, are varied by turning the centering control. The condenser across the centering control provides compensation at very low frequencies.

VERTICAL AMPLIFIER. The vertical amplifier channel consists of: A cathode follower input stage, with a two-position attenuator in the grid circuit, and a gain control in the cathode circuit. A two stage amplifier fed by the low impedance line from the gain control. The portion of the plate load resistor that is common to both stages aids in maintaining the proper low frequency response. A phase splitter stage, direct coupled from the preceding amplifier plate. A push-pull output stage, direct coupled to the deflecting plates, and identical to the push-pull stage in the horizontal amplifier.

SWEEP GENERATOR. The sweep generator is a multivibrator using a twin triode, and produces a saw-tooth shaped output signal. The frequency range is varied in steps by switching condensers of various sizes into the circuit. Vernier adjustment of frequency is achieved by varying the plate and grid resistors.

SYNCHRONIZATION. The sweep generator can be locked-in with the signal in the vertical amplifier at the signal frequency or at a suitable sub-harmonic. This is accomplished by feeding a small portion of the signal in the vertical amplifier circuits into the grid circuit of the multivibrator. The centertapped synchronizing control makes it possible to lock-in on either the positive or negative peak of the signal. If synchronizing voltages from an external source are used, no choice of lock-in polarity is available.

SOME OSCILLOSCOPE APPLICATIONS

The Oscilloscope is a versatile instrument, as it is possible to show as much as three quantities simultaneously and instantaneously. The instrument is however a basic instrument, like a screwdriver or a lathe, and, like a screwdriver or a lathe, additional equipment is generally required to enable it to demonstrate its capabilities.

While a simple tool like a screwdriver only needs a screw and a guiding hand, a complicated tool like a lathe may require cams, special tool bits, turrets, and, of course, material to work on. Similarly, the oscilloscope can properly be used to show the shape of a signal voltage, within its wide operating limits, against a basis of time. However, many more applications are obviously within its realm, if the instrument is used with the accessories required for the specific application.

While a television sweep signal generator is one of the better known "accessories," used for TV receiver alignment, the application field is not limited to radio or electronics. Oscilloscopes may be made to operate on signals derived from accessories which translate recurrent phenomena, such as mechanical vibration, rotation, pressure, light, heat and sound, into signal voltages of suitable character.

By applying the signal voltage from one source to the vertical amplifier, the signal from another source to the horizontal amplifier, and the signal from a third source to the Z-axis or intensity modulation jack, three quantities may be observed simultaneously.

As an example, these signals could represent cylinder pressure (vertical) against crankshaft rotation (horizontal) in an automobile engine, with timing markers added through the intensity modulation.

As another example, ferrous alloys may be compared by tracing a magnetization curve (B-H curve) of each sample on the screen. Variations are then instantly recognized.

A detailed description of such complicated or special applications does not come within the scope of this manual. A few of the many simple applications more frequently encountered are described below.

MEASUREMENT OF DISTORTION. Distortion is best measured in conjunction with a square wave audio generator in which case the oscilloscope is used to observe the square wave passing through the amplifier. A sine wave may also be used as distortion will result in clipping the tops of the sine wave.

Through the use of a filter network such as a twin T or Wien bridge, the fundamental sine wave may be filtered out and the harmonic distortion observed.

ALIGNMENT OF RECEIVERS. The vertical input of the oscilloscope is connected to the output of the receiver detector. The sweep generator of the oscilloscope is adjusted to the modulation frequency of the signal generator and connected to the horizontal amplifier. The receiver adjustments are then made in accordance with the manufacturer's recommendations. Normally all adjustments are made for maximum indication.

MEASUREMENT OF GAIN. By use of the grid screen, the gain of amplifiers may be figured. The vertical input is moved from stage to stage and the gain noted in terms of the grid screen divisions. Simple calculations will then give the ratio of gain.

TESTING TUBES. An absolute measurement of tube quality is possible by measuring the gain of a stage with several different tubes.

MEASUREMENT OF FREQUENCY. Connect the unknown to the vertical input and the 60 cycle test voltage to the horizontal input. The unknown frequency may be identified by the following diagrams:

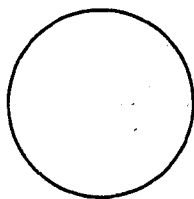

RATIO 1:1

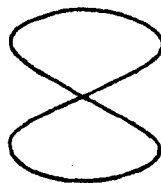

RATIO 2:1

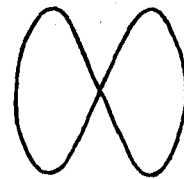

RATIO 1:2

The ratio is established by counting the number of loops vertically and the number horizontally.

MEASUREMENT OF PHASE. The connections outlined under Frequency are used but for phase measurement, the frequency of both inputs must be the same—identify the phase difference by the following diagrams.

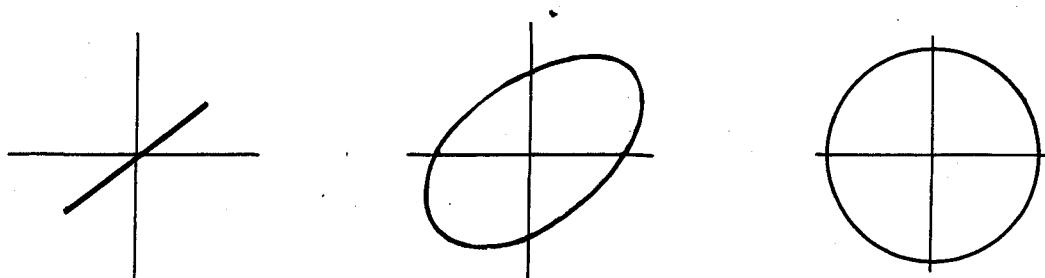

PHASE DIFFERENCE 0° PHASE DIFFERENCE 45° PHASE DIFFERENCE 90°

HUM CHECKING AND IDENTIFICATION. Use same connections as outlined under frequency. Use a test prod connected to the vertical input and connect the ground post of the oscilloscope to the chassis under test. Start at the output transformer where the hum will show as either an oval (60 cycle hum) or a figure eight (120 cycle hum). 60 cycle hum usually results from inductive pickup and can be corrected by moving the audio transformers to a different angle to reduce the coupling from the power transformer. 120 cycle hum results from inadequate or defective filtering in the rectified power supply. This type can be followed directly to its source as the figure eight will become larger as the defective filter condenser is approached. The correction is to replace the defective condenser.

AUTO RADIO VIBRATOR TESTING. Hours can be saved by using the scope in servicing auto radio power supplies. In using the scope, connect the vertical plates across the whole primary winding of the transformer at the vibrator socket. Comparing this picture with the patterns below, any trouble can be quickly spotted. Figure 1 is the ideal pattern. Figure 2 results from a worn vibrator where the contacts are pitted or bouncing. When the buffer condenser opens up, the long pip shown in Figure 3 is present. A shorted buffer condenser or an overloaded circuit shows up as in Figure 4.

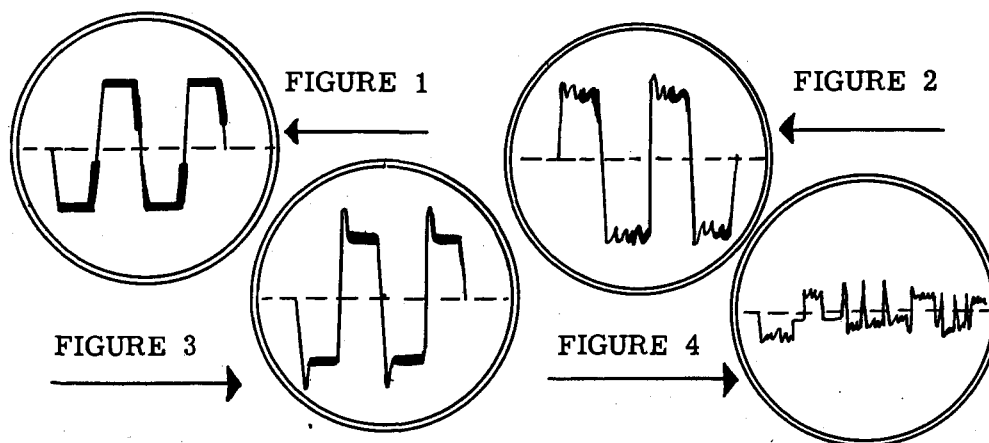

TROUBLE SHOOTING. By the use of a crystal probe into the vertical input of the scope and a modulated signal from a signal generator feeding into the dead receiver, the oscilloscope makes an excellent signal tracer. The signal may be traced from the antenna to the detector with the crystal probe. Beyond the detector, a test prod may be used to follow the audio portion. The defective stage is easily located.

OSCILLOSCOPE AS AC VOLTMETER. By applying a known voltage to the vertical input and measuring it on the grid screen, unknown voltages may be measured by comparison.

BIBLIOGRAPHY

While many issues of the popular radio and service magazines have carried excellent articles on the construction and application of oscilloscopes, and their reading is highly recommended, we also suggest the following excellent books:

RUITER "Modern Oscilloscopes and Their Uses"
SYLVANIA "How To Service Radios With An Oscilloscope"
HICKOK "How To Use The CR Oscilloscope In Servicing Radio and TV"
RIDER "The Cathode-Ray Tube At Work"
TURNER "Radio Test Instruments"
EDITORS & ENGINEERS "Radio Handbook"
ARRL "Radio Amateurs Handbook"
RIDER & USLAN "Encyclopedia on Cathode-Ray Oscilloscopes and Their Uses"

The Allen B. DuMont Labs., Passaic, N. J., supply a number of different pamphlets on using oscilloscopes and make the finest factory built scopes in the world.

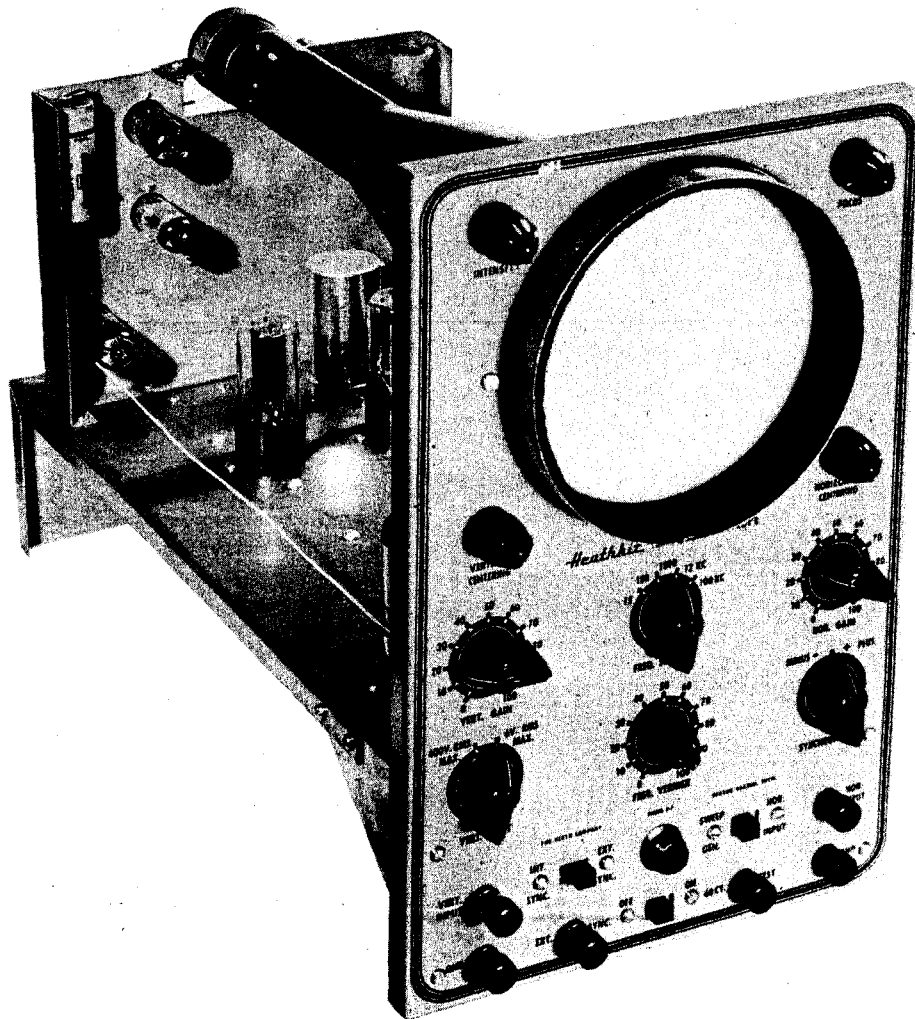

SERVICE

In event continued operational difficulties of the completed instrument are experienced, may we remind you that the Heath Company has provided a technical consultation service. Every effort will be made to assist you through correspondence. May we emphasize that in all correspondence this instrument should be referred to as the Model 0-7 Oscilloscope.

The facilities of the Heath Company Service Department are also available. Your instrument may be returned for inspection, repair and calibration for a service charge of \$5.00 plus the cost of any additional material that may be required. This service policy applies only to completed instruments constructed in accordance with the instructions as stated in the manual. Instruments that are not completed or instruments that are modified will not be accepted for repair. Instruments showing evidence of acid core solder or paste fluxes will be returned not repaired.

The Heath Company is willing to offer its utmost cooperation to assist you in obtaining proper operation of your instrument. The repair service is available until one year from the date of purchase.

NOTE: Before returning this unit, be sure all parts are securely mounted. Attach a tag to the instrument giving name, address and trouble experienced. Place padding over the face of the cathode-ray tube. Pack in a rugged container, preferably wood, using at least three inches of shredded newspaper or excelsior on all sides. Do not ship in original carton only as this carton is not considered adequate for safe shipment of the completed instrument. Ship by prepaid express, if possible. Return shipment will be made by express collect. Note that a carrier cannot be held liable for damage in transit if packing, in his opinion, is insufficient.

Prices are subject to change without notice. The Heath Company reserves the right to change the design without incurring liability for equipment previously supplied.

WARRANTY

The Heath Company limits its warranty on any part supplied with any Heathkit (except tubes, meters, and rectifiers, where the original manufacturer's guarantee only applies) to the replacement within three (3) months of said part which, when returned with prior permission, postpaid, was, in the judgment of the Heath Company, defective at the time of sale.

The assembler is urged to follow the instructions exactly as provided. The Heath Company assumes no responsibility or liability for any damages or injuries sustained in the assembly of the device or in the operation of the completed instrument.

HEATH COMPANY Benton Harbor, Michigan

WIRING OF EXPORT TYPE 110/220 VOLT POWER TRANSFORMERS

These transformers have a dual primary for use on either 110 Volts or 220 Volts.
Wire as shown.

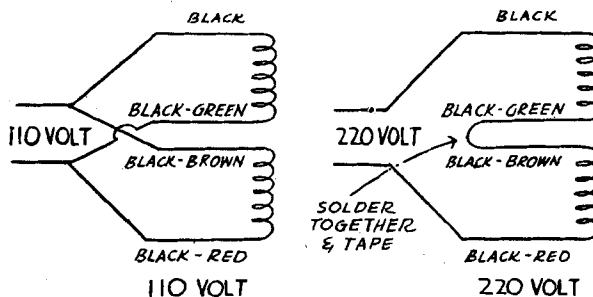

O-7 Oscilloscope Parts List

Part No.	Parts Per Kit	Description	Part No.	Parts Per Kit	Description
Resistors			Tubes-Lamp		
1-6	7	470 ohms	411-1	1	5BP1 or 5BP4 or 5GP1 tube
1-14	1	3.3k ohms	411-3	2	5Y3 tubes
1-20	4	10k ohms	411-4	1	6C4 tube
1-22	2	22k ohms	411-5	2	6J5 tubes
1-25	5	47k ohms	411-24	4	12AT7 tubes
1-26	1	100k ohms	412-1	1	#47 pilot lamp
1-29	1	220k ohms	Knobs-Terminals		
1-33	3	470k ohms	462-1	6	pointer knobs
1-34	1	680k ohms	462-4	4	acorn knobs
1-35	6	1 megohm	426-1	6	binding posts
1-38	2	3.3 megohms	436-3	1	red banana jack
1-2A	1	1k ohm 1 watt	437-1	1	banana jack insert
1-5A	4	22k ohms 1 watt	Sheet metal parts		
1-4B	1	15k ohms 2 watt	90-1	1	cabinet
1-8B	1	1 megohm 2 watt	200-M1	1	chassis
Condensers			203-2	1	panel
31-2	1	4-30 trimmer	204-M1	2	panel brackets
21-6	1	27 MMF	204-M3	1	trimmer mounting bracket
20-4	1	270 MMF	204-M5	1	CR tube bracket
21-14	1	1000 MMF	204-9	1	angle bracket
20-7	1	2000 MMF (.002 MFD)	205-M5	1	shield plate
23-5	1	.01 MFD - 2000 volt	207-M1	2	CR tube mounting clamps
23-8	3	.02 MFD	210-M1	1	CR tube panel ring
23-10	4	.05 MFD	211-1	1	handle
23-11	1	.1 MFD	Screws-Nuts-Washers		
23-13	3	.25 MFD	250-2	10	3-48 screws
23-15	2	.5 MFD	250-4	2	4-40 screws
24-2	1	1 MFD High Voltage	250-9	40	6-32 screws
25-2	2	8 MFD - 450 volt	250-8	4	#6 Sheet metal screws
25-4	1	10 MFD - 25 volt	250-18	4	8-32 screws
25-8	1	20-20-10-10- MFD - 450 volt	250-19	2	10-24 handle screws
Controls-Switches			252-1	10	3-48 nuts
10-7	1	5k control	252-2	2	4-40 nuts
10-11	3	50k controls	252-3	45	6-32 nuts
10-13	1	200k CT control	252-4	4	8-32 nuts
10-15	1	500k control	252-7	11	control nuts
10-17	1	1 meg control	252-9	1	speednut for jack
12-1	1	5k - 5k dual control	253-1	4	fiber flat washers
12-3	1	1 meg - 8 meg dual control	253-2	4	fiber shoulder washers
60-1	1	SPST slide switch	253-10	10	control nickel washers
60-2	2	DPDT slide switches	254-1	39	#6 lockwashers
63-3	1	2 position rotary switch	254-2	4	#8 lockwashers
63-8	1	4 position rotary switch	254-4	11	control lockwashers
Sockets-Terminal strips			259-1	7	solder lugs
434-2	4	octal sockets	Miscellaneous		
434-15	1	7 pin miniature socket	54-1	1	power transformer
434-16	4	9 pin noval sockets	481-1	1	condenser mounting wafer
434-24	1	CR tube socket	421-1	1	fuse
431-1	1	1 lug terminal strip	422-1	1	fuse block
431-2	6	2 lug terminal strips	414-1	1	grid screen
431-5	1	4 lug terminal strip	261-1	4	rubber feet
Pilot light assembly			73-1	1	3/8 grommet
252-12	1	nut	73-2	1	3/4 grommet
413-1	1	jewel	89-1	1	1 line cord
434-22	1	socket	344-1	1	roll hookup wire
455-1	1	bushing	340-2	1	length bare wire
			346-1	1	length spaghetti

278. -

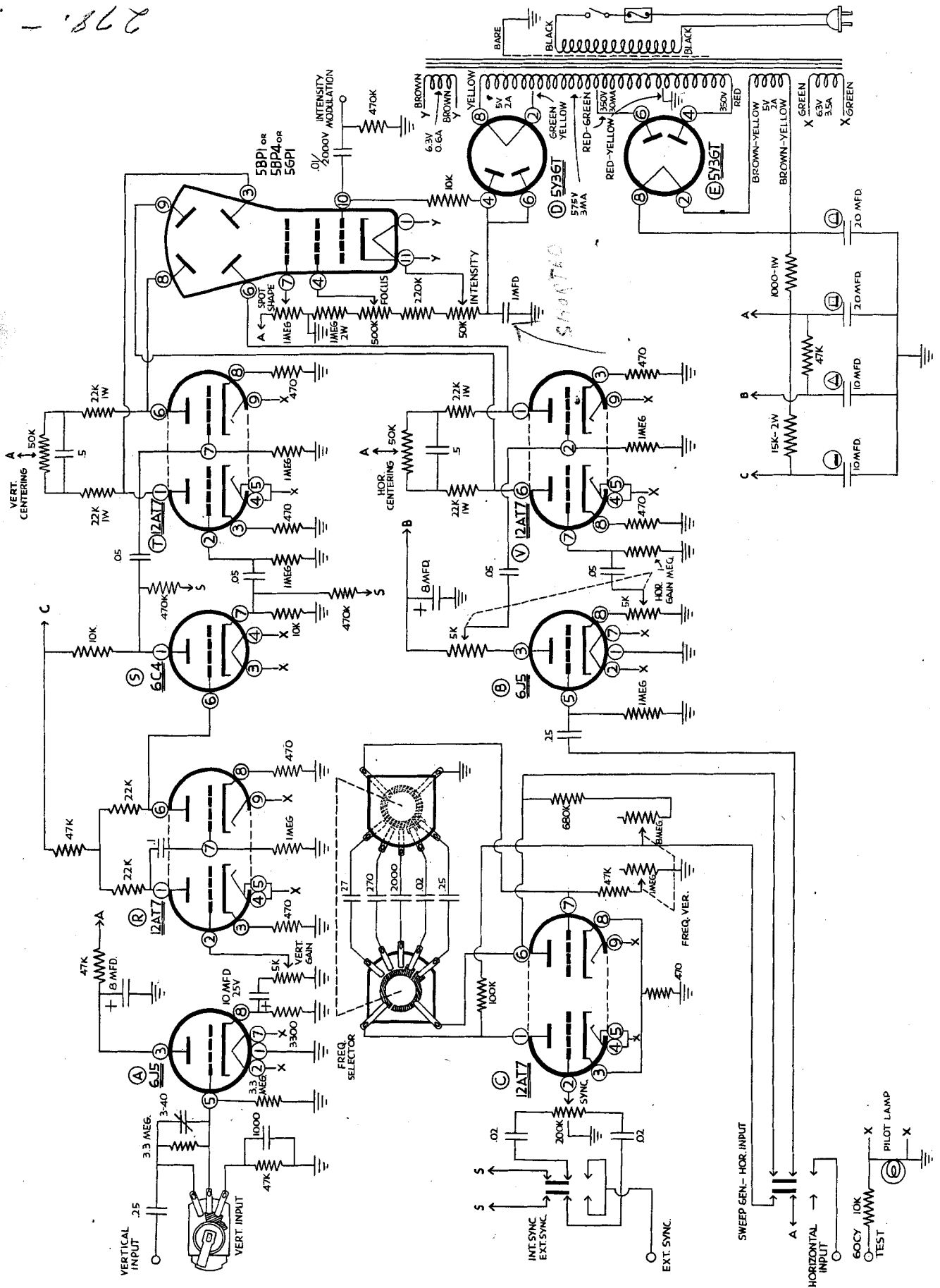

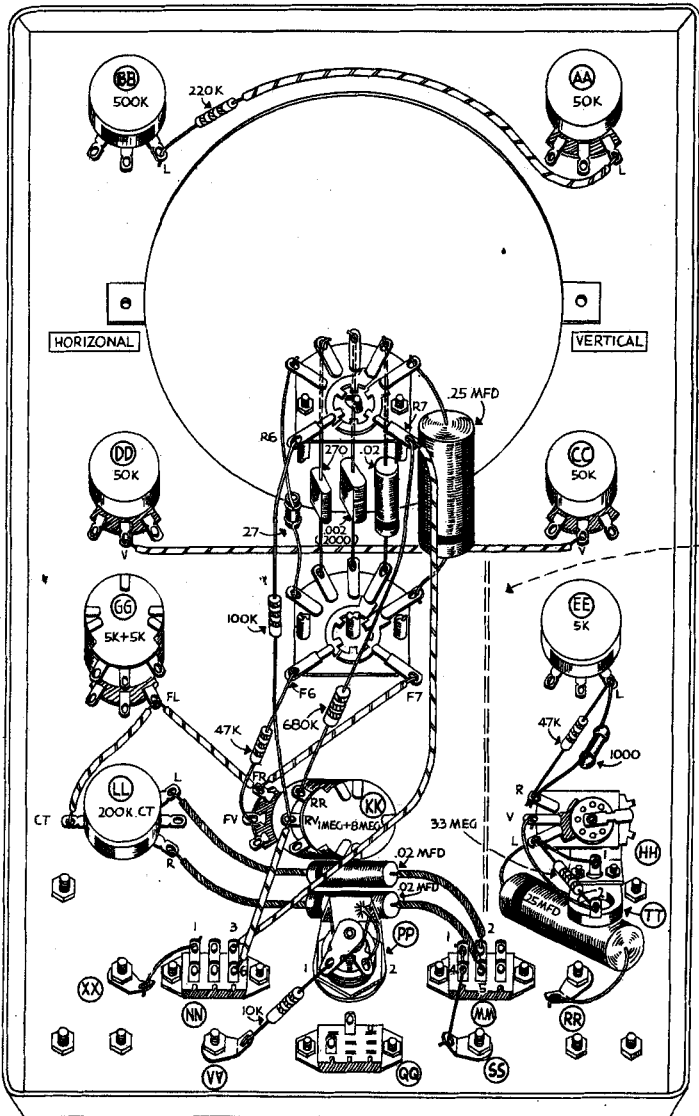
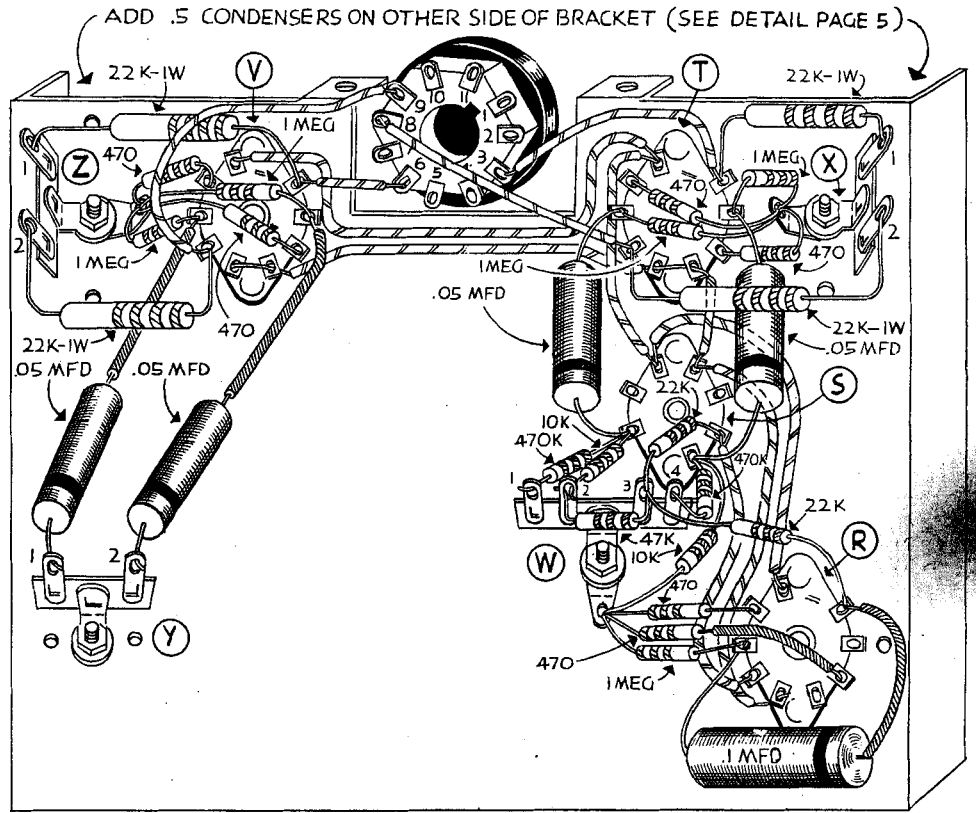
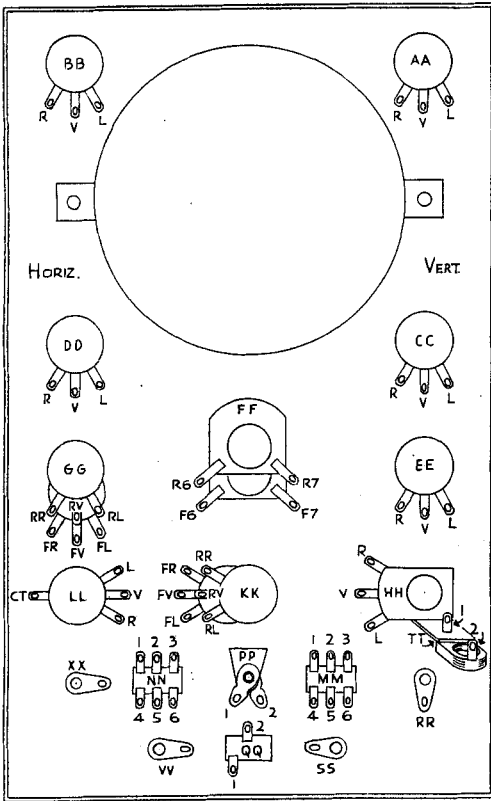

Note... POSITION OF SHIELD WHEN INSTALLED

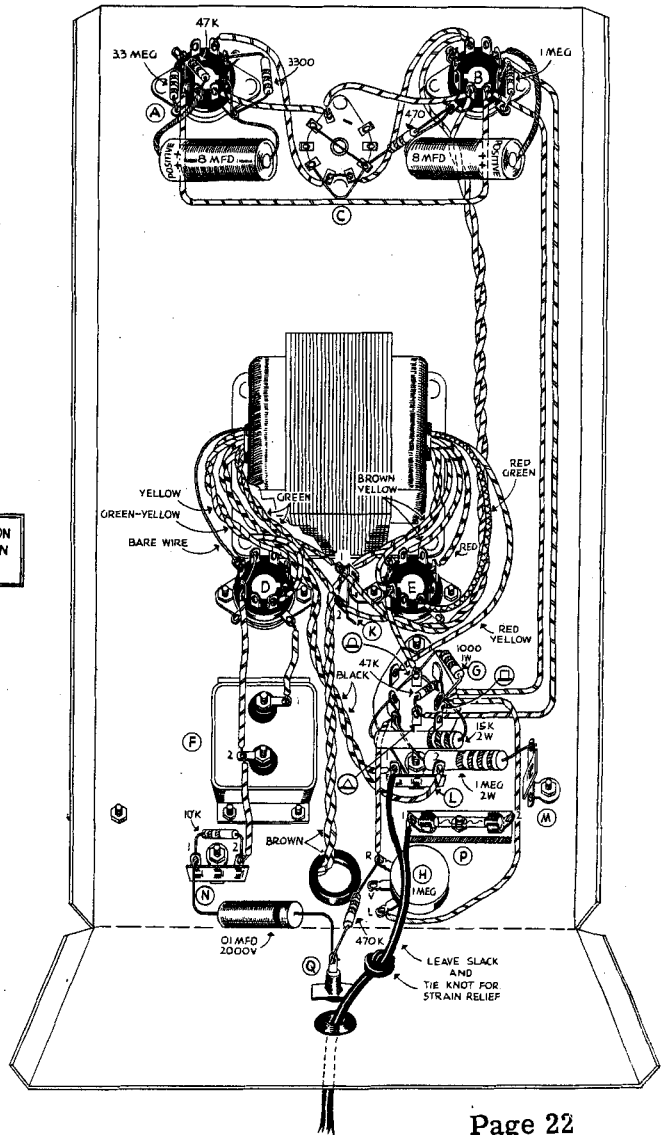

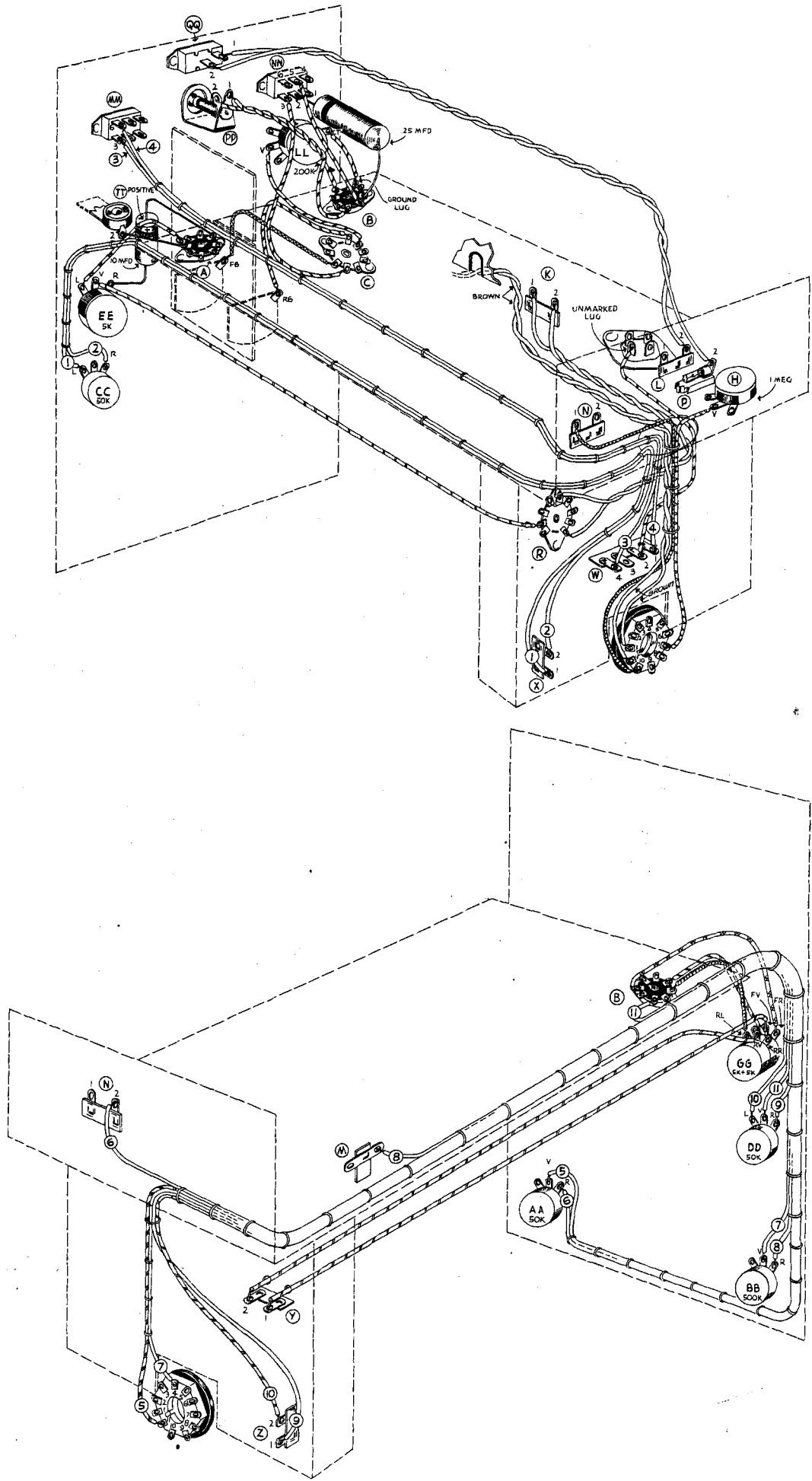

RMA Color Code on Transformers

I.F. TRANSFORMERS

Blue — Plate Lead
 Red — B + Lead
 Green — Grid
 Black — Ground or AVC

If center tapped other grid is green and black striped

AUDIO TRANSFORMERS

Blue — Plate Lead
 Red — B + Lead
 Brown — Other Plate on Push Pull
 Green — Grid Lead
 Black — Ground Lead
 Yellow — Other Grid on Push Pull

POWER TRANSFORMERS PRIMARY — BLACK

High Voltage Plate — Red
 Center Tap Red and Yellow Striped

Rectifier Filament — Yellow
 Center Tap Yellow and Blue

Filament No. 1 — Green
 Center Tap Green and Yellow

Filament No. 2 — Brown
 Center Tap — Brown and Yellow

Filament No. 3 — Slate
 Center Tap — Slate and Yellow

Soldering

The most important thing in good soldering is to heat the joint and allow the solder to flow into it. The solder should melt from contact with the joint rather than with the iron. Never use pastes or acids in radio work.

Use only rosin core solder. Never depend on the solder to hold a joint. Always make a firm connection with the wire before applying solder. To tin a soldering iron (soldering cannot be done with the bare copper) file the surface lightly while the iron is hot and then quickly apply a generous amount of rosin core solder while the filed surface is still bright. Wipe off excess solder with a cloth.

Tin all four sides of the tip in this manner.

The terminals must be clean, and preferably tinned. On some terminals that are hard to solder to (nickel plated f.i.) it is desirable to pre-tin the surface before installation or connection. Clean (scrape or sandpaper) the surface, heat with iron and apply rosin core solder liberally. Wipe off or shake off excess solder.

Recommended Tools

A good electric soldering iron (100 watt with small tip)

Long or needle nose pliers 6".

Diagonal or side cutting pliers (5" or 6").

























An assortment of screw drivers flat and Phillips type.

File. Round and flat types.

Purchase quality tools and you will enjoy and use them many years.

American Beauty soldering irons, Plomb, and Williams pliers are recommended.

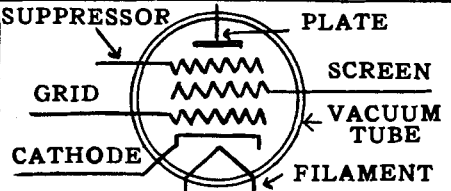
Symbols Used in Radio Circuits

	ANTENNA OR AERIAL		VARIABLE CONDENSER		QUARTZ CRYSTAL
	CHASSIS OR GROUND		ELECTROLYTIC CONDENSER SHOWING POLARITY		CONNECTION OF TWO WIRES
	AIR CORE COIL		SWITCH		NO CONNECTION
	AIR CORE TRANSFORMER OR COIL		ROTARY SWITCH		FUSE
	R.F. CHOKE		SPEAKER		PHONE PLUG
	FILTER OR IRON CORE CHOKE . . .		METER	K =	1000
	IRON CORE TRANSFORMER		PILOT LIGHT	M =	1,000,000
	FIXED RESISTOR		PHONE JACK		OHM.
	VARIABLE RESISTOR OR POTENTIOMETER			MF =	MICROFARAD
	FIXED CONDENSER			MMF =	MICRO MICROFARAD

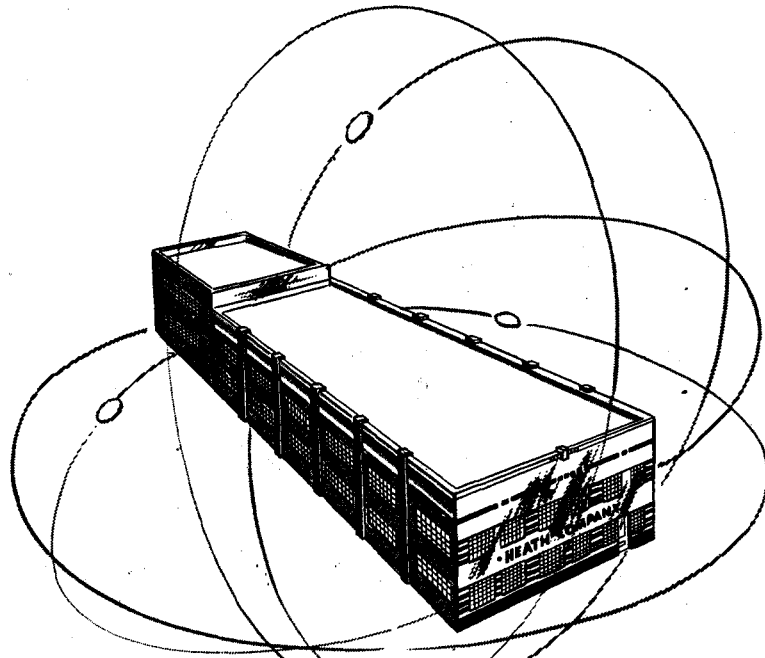

THE HEATH COMPANY
BENTON HARBOR, MICH.